

Zerlegung:

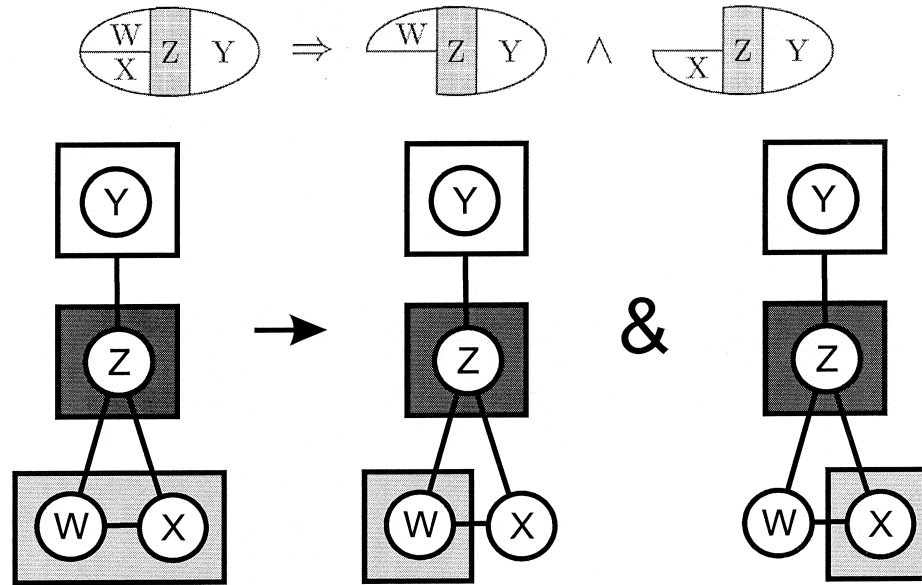

Schwache Vereinigung:

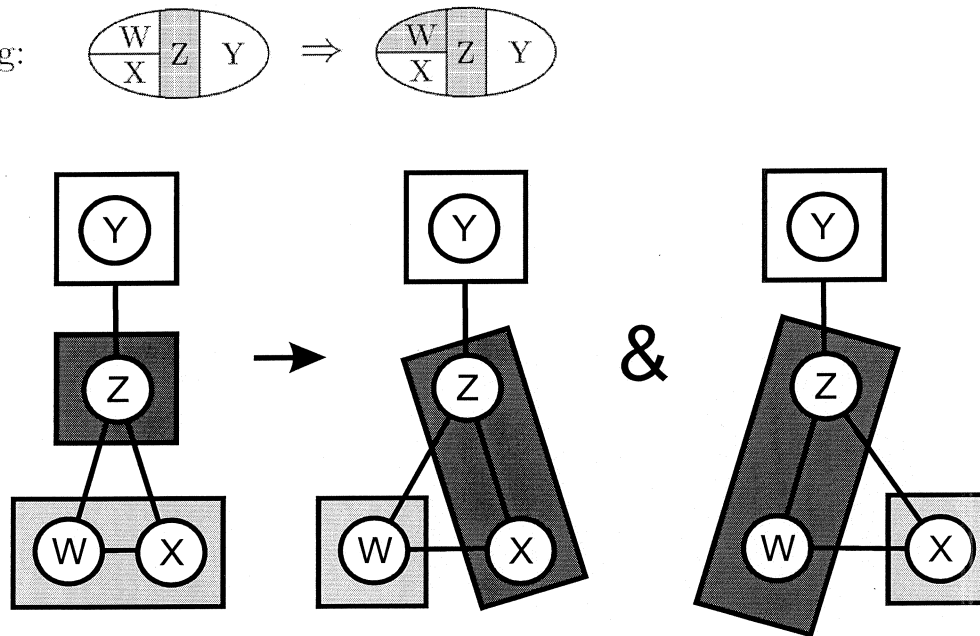

Learning irrelevant information W cannot render irrelevant information X relevant.

Zusammenziehung:

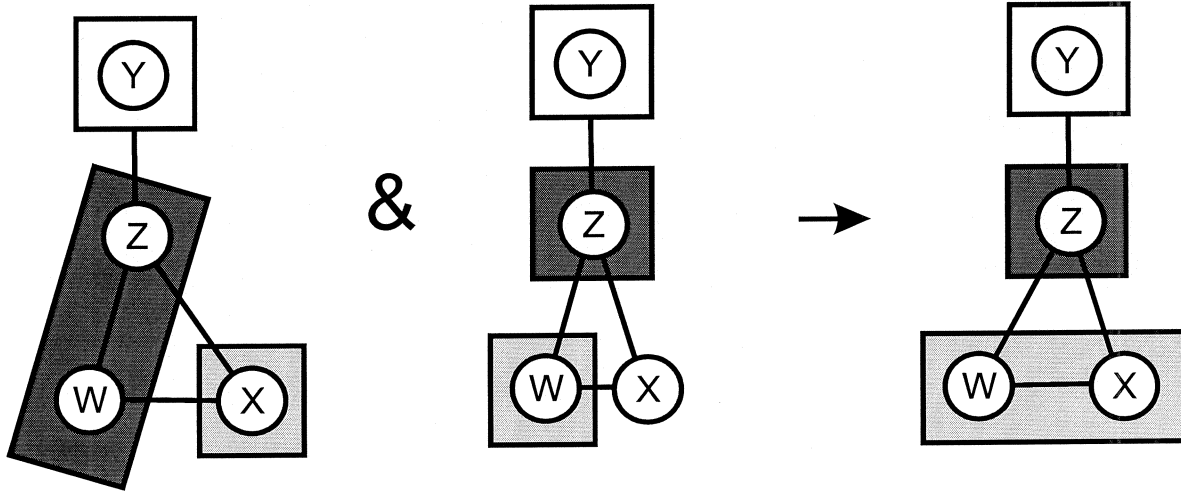
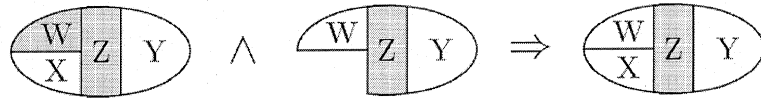

If X is irrelevant (to Y) after having learnt some irrelevant information W, then X must have been irrelevant before.

Schnitt:

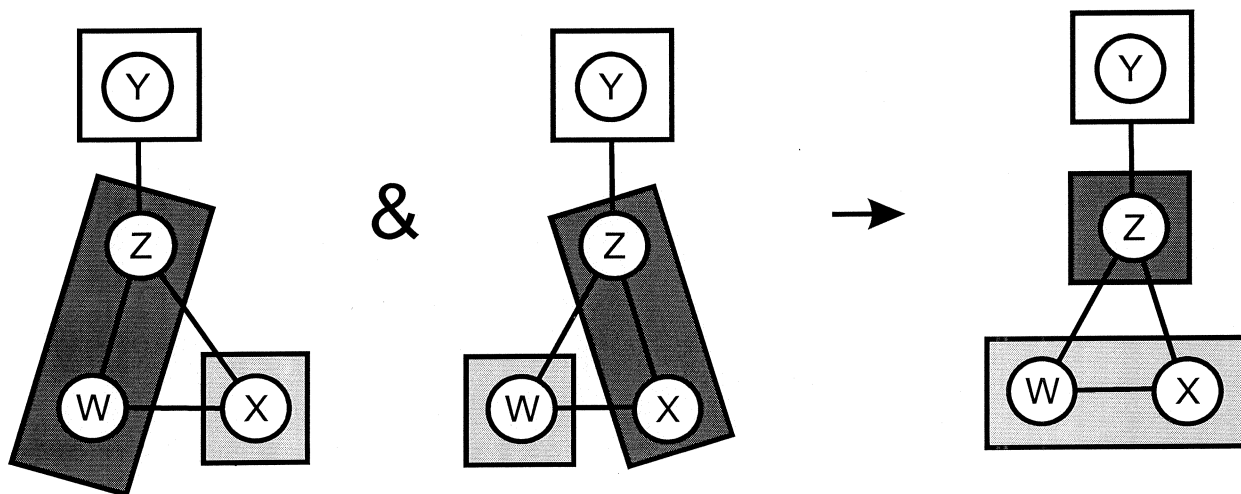
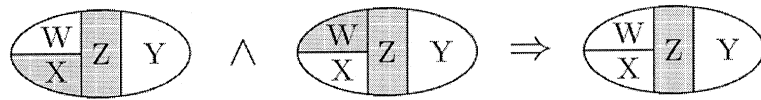

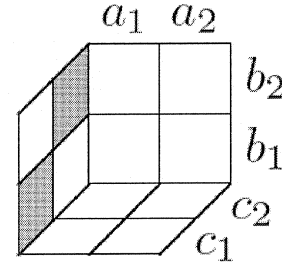
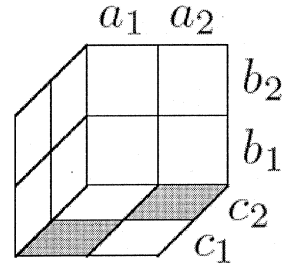
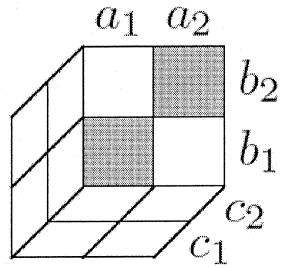
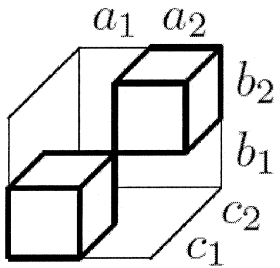

$$A \perp\!\!\!\perp B \mid C$$

$$B \perp\!\!\!\perp C \mid A$$

$$A \perp\!\!\!\perp C \mid B$$

With $Z=\{\}$ according to the intersection axiom, there should be the following conclusions:

$$A \perp\!\!\!\perp BC$$

$$B \perp\!\!\!\perp AC$$

$$C \perp\!\!\!\perp AB$$

Decomposition \longrightarrow

$$A \perp\!\!\!\perp B$$

$$B \perp\!\!\!\perp C$$

$$C \perp\!\!\!\perp A$$

