

Fuzzy Systems

Fuzzy Control

Prof. Dr. Rudolf Kruse **Christoph Doell**

{kruse,doell}@ovgu.de

Otto-von-Guericke University of Magdeburg

Faculty of Computer Science

Institute for Intelligent Cooperating Systems

Outline

1. Mamdani-Assilian Controller

Architecture of a Fuzzy Controller

Cartpole Problem

Table-based Control Function

Combination of Rules

Defuzzification

2. Examples

3. Takagi-Sugeno Controller

4. Control based on Fuzzy Equivalence Relations

Architecture of a Fuzzy Controller

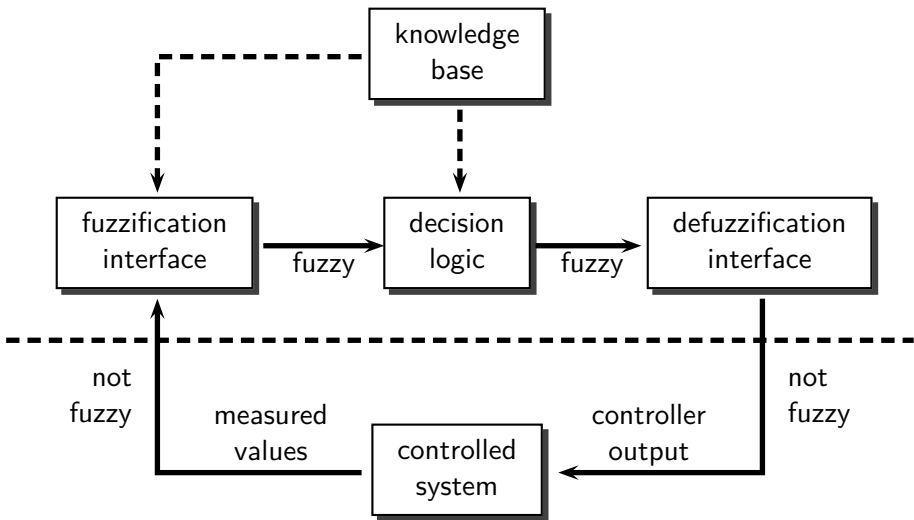

Example: Cartpole Problem (cont.)

X_1 is partitioned into 7 fuzzy sets.

Support of fuzzy sets: intervals with length $\frac{1}{4}$ of whole range X_1 .

Similar fuzzy partitions for X_2 and Y .

Next step: specify rules

if ξ_1 is $A^{(1)}$ and ... and ξ_n is $A^{(n)}$ then η is B ,

$A^{(1)}, \dots, A^{(n)}$ and B represent linguistic terms corresponding to $\mu^{(1)}, \dots, \mu^{(n)}$ and μ according to X_1, \dots, X_n and Y .

Let the rule base consist of k rules.

Example: Cartpole Problem (cont.)

		θ						
		nb	nm	ns	az	ps	pm	pb
$\dot{\theta}$	nb			ps	pb			
	nm				pm			
	ns	nm		ns	ps			
	az	nb	nm	ns	az	ps	pm	pb
	ps				ns	ps		pm
	pm				nm			
	pb				nb	ns		

19 rules for cartpole problem, e.g.

If θ is *approximately zero* and $\dot{\theta}$ is *negative medium*
then F is *positive medium*.

Definition of Table-based Control Function

Measurement $(x_1, \dots, x_n) \in X_1 \times \dots \times X_n$ is forwarded to decision logic.

Consider rule

if ξ_1 is $A^{(1)}$ and \dots and ξ_n is $A^{(n)}$ then η is B .

Decision logic computes degree to ξ_1, \dots, ξ_n fulfills premise of rule.

For $1 \leq \nu \leq n$, the value $\mu^{(\nu)}(x_\nu)$ is calculated.

Combine values conjunctively by $\alpha = \min \{ \mu^{(1)}, \dots, \mu^{(n)} \}$.

For each rule R_r with $1 \leq r \leq k$, compute

$$\alpha_r = \min \{ \mu_{i_1, r}^{(1)}(x_1), \dots, \mu_{i_n, r}^{(n)}(x_n) \}.$$

Definition of Table-based Control Function II

Output of $R_r =$ fuzzy set of output values.

Thus “cutting off” fuzzy set μ_{i_r} associated with conclusion of R_r at α_r .

So for input (x_1, \dots, x_n) , R_r implies fuzzy set

$$\mu_{x_1, \dots, x_n}^{\text{output}(R_r)} : Y \rightarrow [0, 1],$$
$$y \mapsto \min \left\{ \mu_{i_1, r}^{(1)}(x_1), \dots, \mu_{i_n, r}^{(n)}(x_n), \mu_{i_r}(y) \right\}.$$

If $\mu_{i_1, r}^{(1)}(x_1) = \dots = \mu_{i_n, r}^{(n)}(x_n) = 1$, then $\mu_{x_1, \dots, x_n}^{\text{output}(R_r)} = \mu_{i_r}$.

If for all $\nu \in \{1, \dots, n\}$, $\mu_{i_\nu, r}^{(\nu)}(x_\nu) = 0$, then $\mu_{x_1, \dots, x_n}^{\text{output}(R_r)} = 0$.

Combination of Rules

The decision logic combines the fuzzy sets from all rules.

The **maximum** leads to the output fuzzy set

$$\mu_{x_1, \dots, x_n}^{\text{output}} : Y \rightarrow [0, 1],$$
$$y \mapsto \max_{1 \leq r \leq k} \left\{ \min \left\{ \mu_{i_1, r}^{(1)}(x_1), \dots, \mu_{i_n, r}^{(n)}(x_n), \mu_{i_r}(y) \right\} \right\}.$$

Then $\mu_{x_1, \dots, x_n}^{\text{output}}$ is passed to defuzzification interface.

Rule Evaluation

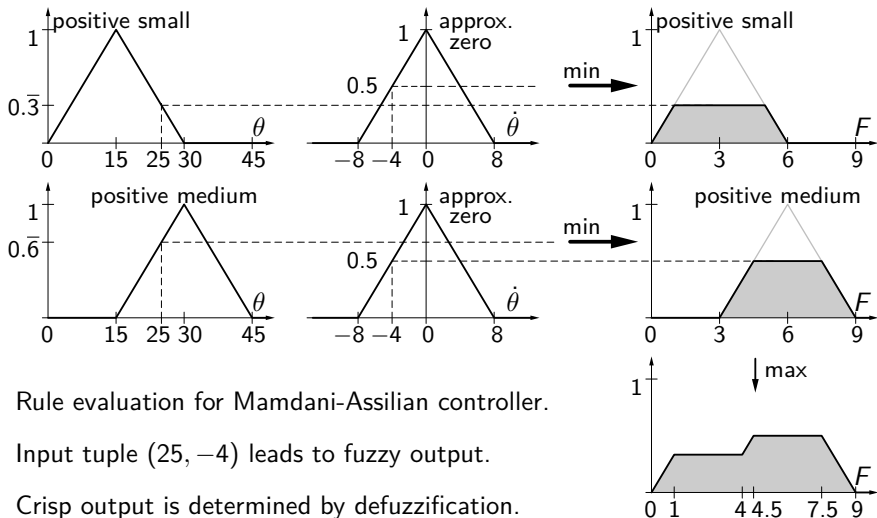

Rule evaluation for Mamdani-Assilian controller.

Input tuple $(25, -4)$ leads to fuzzy output.

Crisp output is determined by defuzzification.

Defuzzification

So far: mapping between each (n_1, \dots, n_n) and $\mu_{x_1, \dots, x_n}^{\text{output}}$.

Output = description of output value as fuzzy set.

Defuzzification interface derives crisp value from $\mu_{x_1, \dots, x_n}^{\text{output}}$.

This step is called **defuzzification**.

Most common methods:

- max criterion,
- mean of maxima,
- center of gravity.

The Max Criterion Method

Choose an arbitrary $y \in Y$ for which $\mu_{x_1, \dots, x_n}^{\text{output}}$ reaches the maximum membership value.

Advantages:

- Applicable for arbitrary fuzzy sets.
- Applicable for arbitrary domain Y (even for $Y \neq \mathbb{R}$).

Disadvantages:

- Rather class of defuzzification strategies than single method.
- Which value of maximum membership?
- Random values and thus non-deterministic controller.
- Leads to discontinuous control actions.

The Mean of Maxima (MOM) Method

Preconditions:

- (i) Y is interval
- (ii) $Y_{\text{Max}} = \{y \in Y \mid \forall y' \in Y : \mu_{x_1, \dots, x_n}^{\text{output}}(y') \leq \mu_{x_1, \dots, x_n}^{\text{output}}(y)\}$ is non-empty and measurable
- (iii) Y_{Max} is set of all $y \in Y$ such that $\mu_{x_1, \dots, x_n}^{\text{output}}$ is maximal

Crisp output value = mean value of Y_{Max} .

if Y_{Max} is finite:

$$\eta = \frac{1}{|Y_{\text{Max}}|} \sum_{y_i \in Y_{\text{Max}}} y_i$$

if Y_{Max} is infinite:

$$\eta = \frac{\int_{y \in Y_{\text{Max}}} y \, dy}{\int_{y \in Y_{\text{Max}}} dy}$$

MOM can lead to discontinuous control actions.

Center of Gravity (COG) Method

Same preconditions as MOM method.

η = center of gravity/area of $\mu_{x_1, \dots, x_n}^{\text{output}}$

If Y is finite, then

$$\eta = \frac{\sum_{y_i \in Y} y_i \cdot \mu_{x_1, \dots, x_n}^{\text{output}}(y_i)}{\sum_{y_i \in Y} \mu_{x_1, \dots, x_n}^{\text{output}}(y_i)}.$$

If Y is infinite, then

$$\eta = \frac{\int_{y \in Y} y \cdot \mu_{x_1, \dots, x_n}^{\text{output}}(y) dy}{\int_{y \in Y} \mu_{x_1, \dots, x_n}^{\text{output}}(y) dy}.$$

Center of Gravity (COG) Method

Advantages:

- Nearly always smooth behavior,
- If certain rule dominates once, not necessarily dominating again.

Disadvantage:

- No semantic justification,
- Long computation,
- Counterintuitive results possible.

Also called *center of area (COA) method*:

take value that splits $\mu_{x_1, \dots, x_n}^{\text{output}}$ into 2 equal parts.

Example

Task: compute η_{COG} and η_{MOM} of fuzzy set shown below.

Based on finite set $Y = 0, 1, \dots, 10$ and infinite set $Y = [0, 10]$.

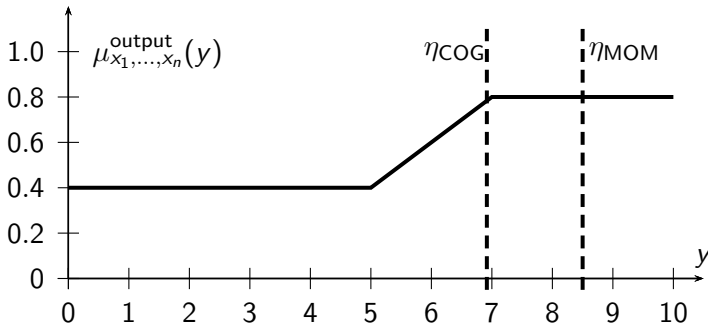

Example for COG

Continuous and Discrete Output Space

$$\begin{aligned} \eta_{\text{COG}} &= \frac{\int_0^{10} y \cdot \mu_{x_1, \dots, x_n}^{\text{output}}(y) dy}{\int_0^{10} \mu_{x_1, \dots, x_n}^{\text{output}}(y) dy} \\ &= \frac{\int_0^5 0.4y dy + \int_5^7 (0.2y - 0.6)y dy + \int_7^{10} 0.8y dy}{5 \cdot 0.4 + 2 \cdot \frac{0.8+0.4}{2} + 3 \cdot 0.8} \\ &\approx \frac{38.7333}{5.6} \approx 6.917 \end{aligned}$$

$$\begin{aligned} \eta_{\text{COG}} &= \frac{0.4 \cdot (0 + 1 + 2 + 3 + 4 + 5) + 0.6 \cdot 6 + 0.8 \cdot (7 + 8 + 9 + 10)}{0.4 \cdot 6 + 0.6 \cdot 1 + 0.8 \cdot 4} \\ &= \frac{36.8}{6.2} \approx 5.935 \end{aligned}$$

Example for MOM

Continuous and Discrete Output Space

$$\begin{aligned}\eta_{\text{MOM}} &= \frac{\int_7^{10} y \, dy}{\int_7^{10} dy} \\ &= \frac{50 - 24.5}{10 - 7} = \frac{25.5}{3} \\ &= 8.5\end{aligned}$$

$$\begin{aligned}\eta_{\text{MOM}} &= \frac{7 + 8 + 9 + 10}{4} \\ &= \frac{34}{4} \\ &= 8.5\end{aligned}$$

Problem Case for MOM and COG

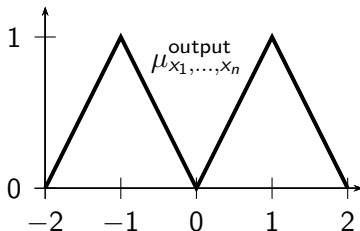

What would be the output of MOM or COG?

Is this desirable or not?

Outline

1. Mamdani-Assilian Controller

2. Examples

Engine Idle Speed Control

Automatic Gear Box

3. Takagi-Sugeno Controller

4. Control based on Fuzzy Equivalence Relations

Example: Engine Idle Speed Control

VW 2000cc 116hp Motor (Golf GTI)

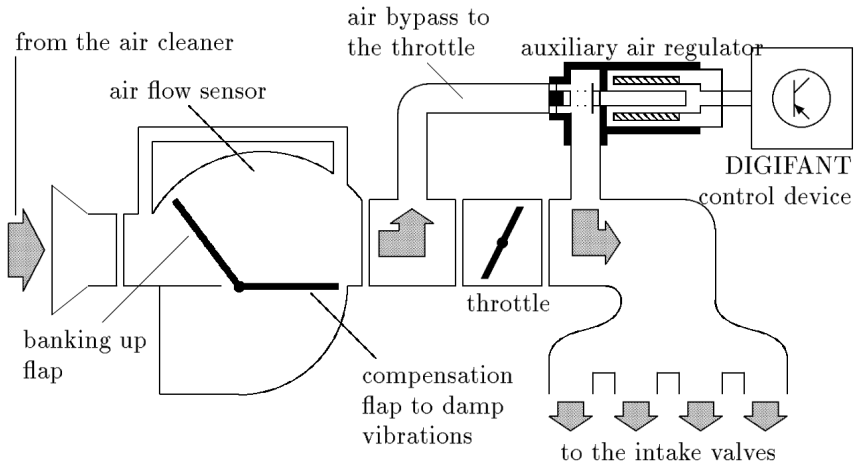

Structure of the Fuzzy Controller

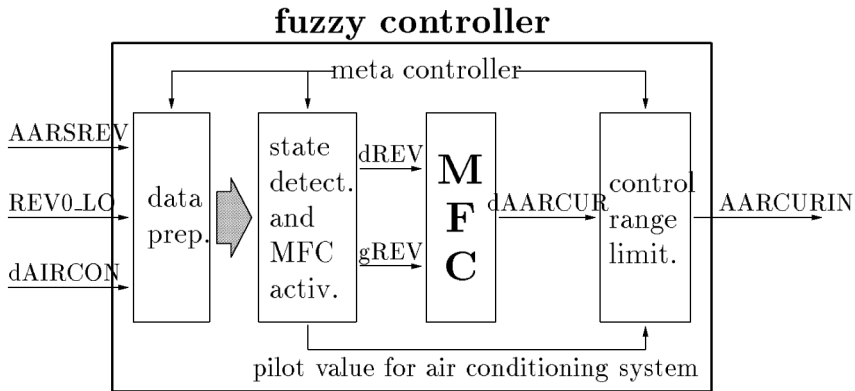

Deviation of the Number of Revolutions

dREV

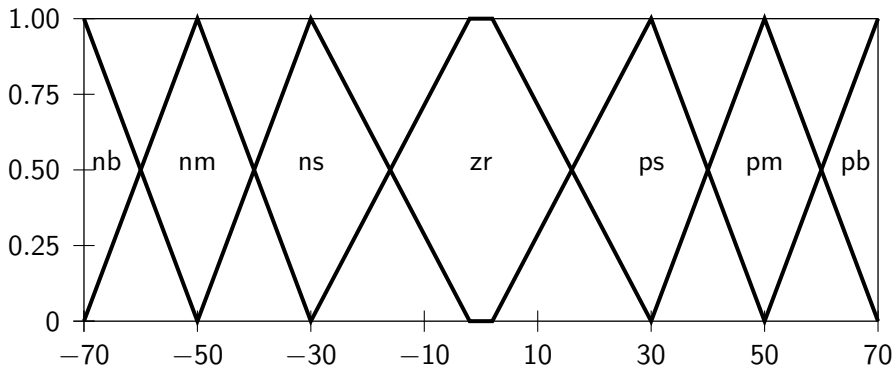

Gradient of the Number of Revolutions

gREV

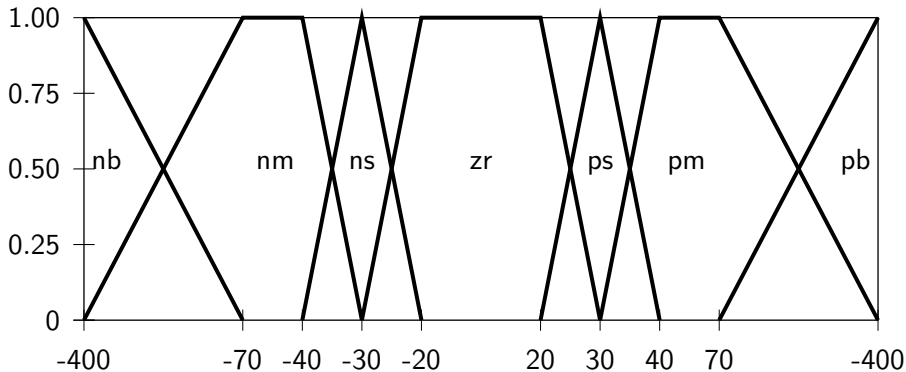

Change of Current for Auxiliary Air Regulator dAARCUR

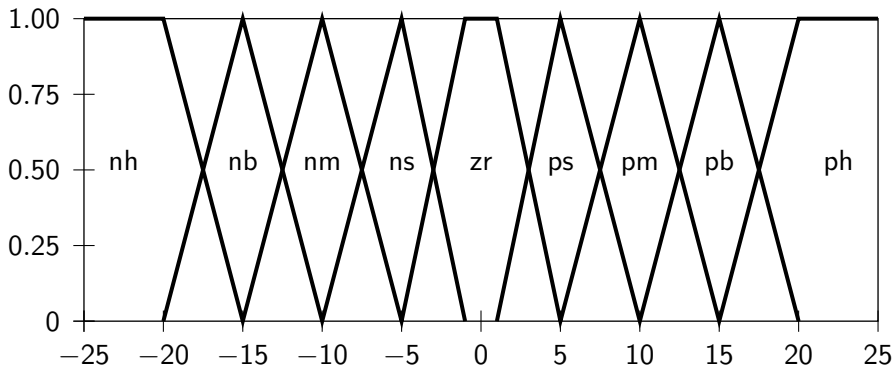

Rule Base

If the deviation from the desired number of revolutions is negative small **and** the gradient is negative medium, **then** the change of the current for the auxiliary air regulation should be positive medium.

		gREV						
		nb	nm	ns	az	ps	pm	pb
dREV	nb	ph	pb	pb	pm	pm	ps	ps
	nm	ph	pb	pm	pm	ps	ps	az
	ns	pb	pm	ps	ps	az	az	az
	az	ps	ps	az	az	az	nm	ns
	ps	az	az	az	ns	ns	nm	nb
	pm	az	ns	ns	ns	nb	nb	nh
	pb	ns	ns	nm	nb	nb	nb	nh

Performance Characteristics

dAARCUR

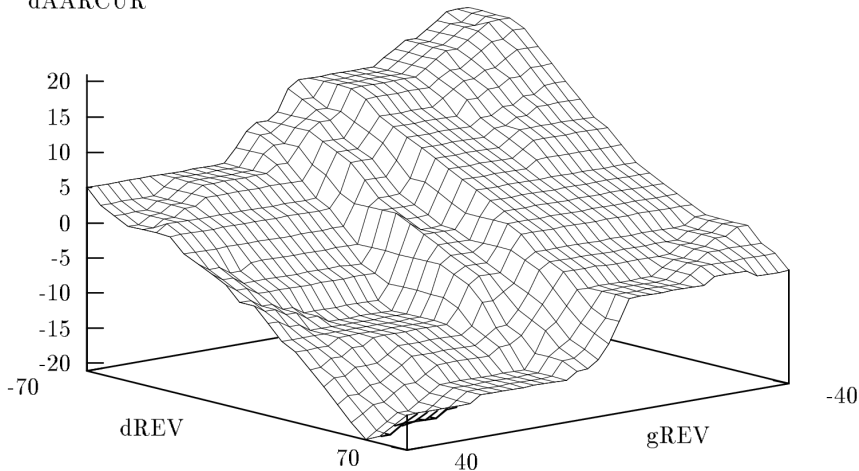

Example: Automatic Gear Box I

VW gear box with 2 modes (eco, sport) in series line until 1994.

Research issue since 1991: individual adaption of set points and no additional sensors.

Idea: car “watches” driver and classifies him/her into calm, normal, sportive (assign sport factor $[0, 1]$), or nervous (calm down driver).

Test car: different drivers, classification by expert (passenger).

Simultaneous measurement of 14 attributes, e.g. , speed, position of accelerator pedal, speed of accelerator pedal, kick down, steering wheel angle.

Example: Automatic Gear Box II

Continuously Adapting Gear Shift Schedule in VW New Beetle

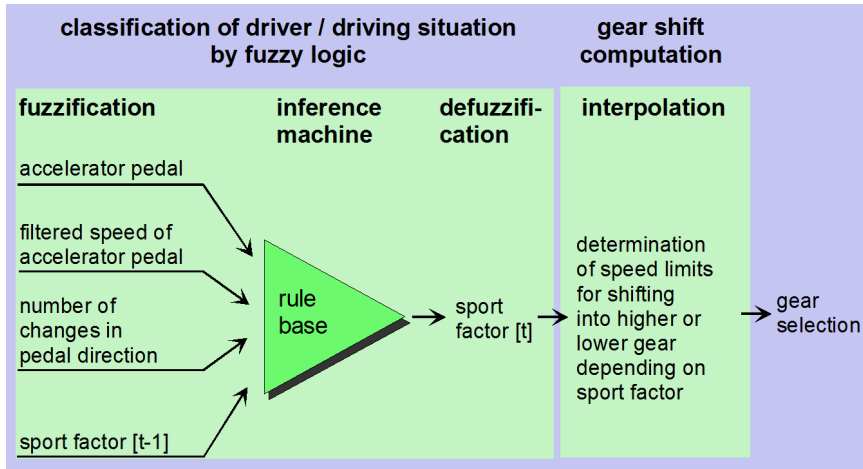

Example: Automatic Gear Box III

Technical Details

Optimized program on Digimat:

24 byte RAM

702 byte ROM

uses 7 Mamdani fuzzy rules

Runtime: 80 ms

12 times per second new sport
factor is assigned.

Research topics:

When fuzzy control?

How to find fuzzy rules?

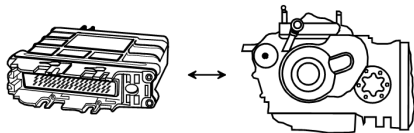

Outline

1. Mamdani-Assilian Controller

2. Examples

3. Takagi-Sugeno Controller

Examples

4. Control based on Fuzzy Equivalence Relations

Takagi-Sugeno Controller

Proposed by Tomohiro Takagi and Michio Sugeno.

Modification/extension of Mamdani controller.

Both in common: fuzzy partitions of input domain X_1, \dots, X_n .

Difference to Mamdani controller:

- no fuzzy partition of output domain Y ,
- controller rules R_1, \dots, R_k are given by

$$R_r : \text{if } \xi_1 \text{ is } A_{i_1, r}^{(1)} \text{ and } \dots \text{ and } \xi_n \text{ is } A_{i_n, r}^{(n)} \\ \text{then } \eta_r = f_r(\xi_1, \dots, \xi_n),$$

$$f_r : X_1 \times \dots \times X_n \rightarrow Y.$$

- Generally, f_r is linear, i.e. $f_r(x_1, \dots, x_n) = a_0^{(r)} + \sum_{i=1}^n a_i^{(r)} x_i$.

Takagi-Sugeno Controller: Conclusion

For given input (x_1, \dots, x_n) and for each R_r , decision logic computes truth value α_r of each premise, and then $f_r(x_1, \dots, x_n)$.

Analogously to Mamdani controller:

$$\alpha_r = \min \left\{ \mu_{i_1,r}^{(1)}(x_1), \dots, \mu_{i_n,r}^{(n)}(x_n) \right\}.$$

Output equals crisp control value

$$\eta = \frac{\sum_{r=1}^k \alpha_r \cdot f_r(x_1, \dots, x_n)}{\sum_{r=1}^k \alpha_r}.$$

Thus no defuzzification method necessary.

Example

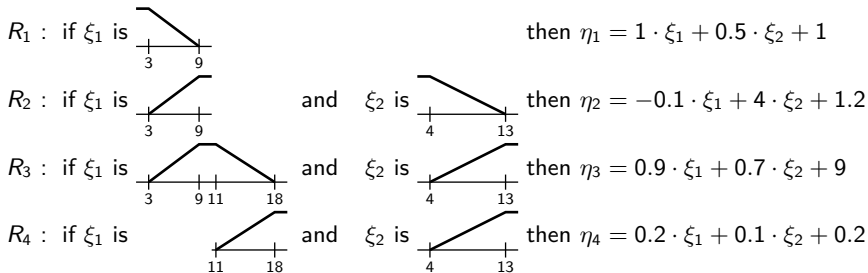

If a certain clause “ x_j is $A_{i,j,r}^{(j)}$ ” in rule R_r is missing, then $\mu_{i,j,r}(x_j) \equiv 1$ for all linguistic values $i_{j,r}$.

For instance, here x_2 in R_1 , so $\mu_{i_2,1}(x_2) \equiv 1$ for all $i_{2,1}$.

Example: Output Computation

input: $(\xi_1, \xi_2) = (6, 7)$

$$\alpha_1 = 1/2 \wedge 1 = 1/2$$

$$\eta_1 = 6 + 7/2 + 1 = 10.5$$

$$\alpha_2 = 1/2 \wedge 2/3 = 1/2$$

$$\eta_2 = -0.6 + 28 + 1.2 = 28.6$$

$$\alpha_3 = 1/2 \wedge 1/3 = 1/3$$

$$\eta_3 = 0.9 \cdot 6 + 0.7 \cdot 7 + 9 = 19.3$$

$$\alpha_4 = 0 \wedge 1/3 = 0$$

$$\eta_4 = 6 + 7/2 + 1 = 10.5$$

$$\text{output: } \eta = f(6, 7) = \frac{1/2 \cdot 10.5 + 1/2 \cdot 28.6 + 1/3 \cdot 19.3}{1/2 + 1/2 + 1/3} = 19.5$$

Example: Passing a Bend

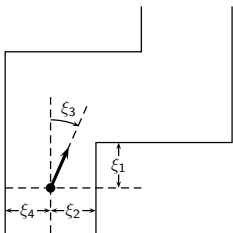
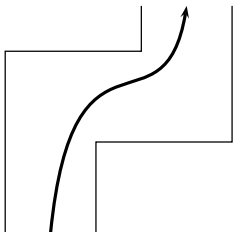

Pass a bend with a car at constant speed.

Measured inputs:

ξ_1 : distance of car to beginning of bend

ξ_2 : distance of car to inner barrier

ξ_3 : direction (angle) of car

ξ_4 : distance of car to outer barrier

η = rotation speed of steering wheel

$X_1 = [0 \text{ cm}, 150 \text{ cm}]$, $X_2 = [0 \text{ cm}, 150 \text{ cm}]$

$X_3 = [-90^\circ, 90^\circ]$, $X_4 = [0 \text{ cm}, 150 \text{ cm}]$

Fuzzy Partitions of X_1 and X_2

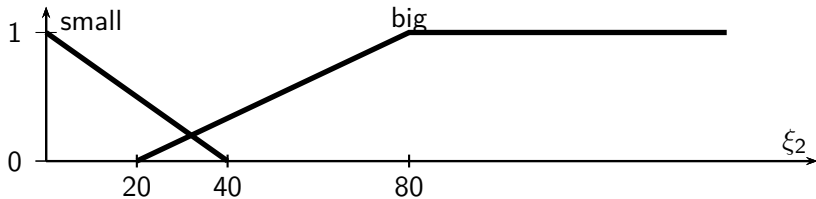
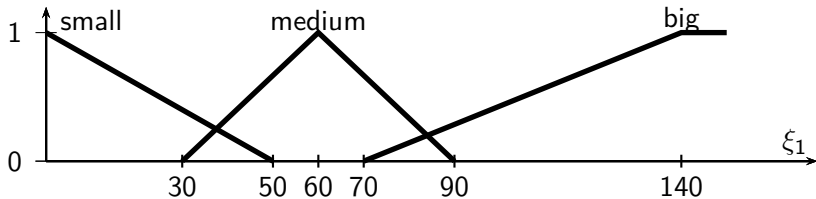

Fuzzy Partitions of X_3 and X_4

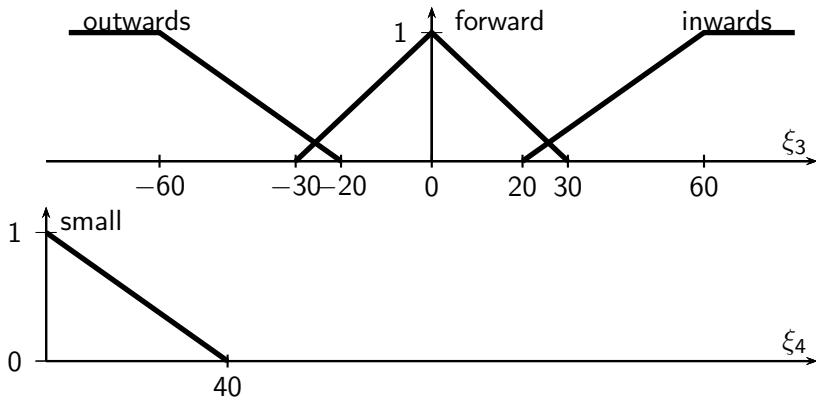

Form of Rules of Car

R_r : **if** ξ_1 is A and ξ_2 is B and ξ_3 is C and ξ_4 is D

$$\text{then } \eta = p_0^{(A,B,C,D)} + p_1^{(A,B,C,D)} \cdot \xi_1 + p_2^{(A,B,C,D)} \cdot \xi_2 \\ + p_3^{(A,B,C,D)} \cdot \xi_3 + p_4^{(A,B,C,D)} \cdot \xi_4$$

$A \in \{\textit{small}, \textit{medium}, \textit{big}\}$

$B \in \{\textit{small}, \textit{big}\}$

$C \in \{\textit{outwards}, \textit{forward}, \textit{inwards}\}$

$D \in \{\textit{small}\}$

$p_0^{(A,B,C,D)}, \dots, p_4^{(A,B,C,D)} \in \mathbb{R}$

Control Rules for the Car

rule	ξ_1	ξ_2	ξ_3	ξ_4	P_0	P_1	P_2	P_3	P_4
R_1	-	-	outwards	small	3.000	0.000	0.000	-0.045	-0.004
R_2	-	-	forward	small	3.000	0.000	0.000	-0.030	-0.090
R_3	small	small	outwards	-	3.000	-0.041	0.004	0.000	0.000
R_4	small	small	forward	-	0.303	-0.026	0.061	-0.050	0.000
R_5	small	small	inwards	-	0.000	-0.025	0.070	-0.075	0.000
R_6	small	big	outwards	-	3.000	-0.066	0.000	-0.034	0.000
R_7	small	big	forward	-	2.990	-0.017	0.000	-0.021	0.000
R_8	small	big	inwards	-	1.500	0.025	0.000	-0.050	0.000
R_9	medium	small	outwards	-	3.000	-0.017	0.005	-0.036	0.000
R_{10}	medium	small	forward	-	0.053	-0.038	0.080	-0.034	0.000
R_{11}	medium	small	inwards	-	-1.220	-0.016	0.047	-0.018	0.000
R_{12}	medium	big	outwards	-	3.000	-0.027	0.000	-0.044	0.000
R_{13}	medium	big	forward	-	7.000	-0.049	0.000	-0.041	0.000
R_{14}	medium	big	inwards	-	4.000	-0.025	0.000	-0.100	0.000
R_{15}	big	small	outwards	-	0.370	0.000	0.000	-0.007	0.000
R_{16}	big	small	forward	-	-0.900	0.000	0.034	-0.030	0.000
R_{17}	big	small	inwards	-	-1.500	0.000	0.005	-0.100	0.000
R_{18}	big	big	outwards	-	1.000	0.000	0.000	-0.013	0.000
R_{19}	big	big	forward	-	0.000	0.000	0.000	-0.006	0.000
R_{20}	big	big	inwards	-	0.000	0.000	0.000	-0.010	0.000

Sample Calculation

Assume that the car is 10 cm away from beginning of bend ($\xi_1 = 10$).

The distance of the car to the inner barrier be 30 cm ($\xi_2 = 30$).

The distance of the car to the outer barrier be 50 cm ($\xi_4 = 50$).

The direction of the car be “forward” ($\xi_3 = 0$).

Then according to all rules R_1, \dots, R_{20} ,
only premises of R_4 and R_7 have a value $\neq 0$.

Membership Degrees to Control Car

	small	medium	big
$\xi_1 = 10$	0.8	0	0

	small	big
$\xi_2 = 30$	0.25	0.167

	outwards	forward	inwards
$\xi_3 = 0$	0	1	0

	small
$\xi_4 = 50$	0

Sample Calculation (cont.)

For the premise of R_4 and R_7 , $\alpha_4 = 1/4$ and $\alpha_7 = 1/6$, resp.

The rules weights $\alpha_4 = \frac{1/4}{1/4+1/6} = 3/5$ for R_4 and $\alpha_5 = 2/5$ for R_7 .

R_4 yields

$$\begin{aligned}\eta_4 &= 0.303 - 0.026 \cdot 10 + 0.061 \cdot 30 - 0.050 \cdot 0 + 0.000 \cdot 50 \\ &= 1.873.\end{aligned}$$

R_7 yields

$$\begin{aligned}\eta_7 &= 2.990 - 0.017 \cdot 10 + 0.000 \cdot 30 - 0.021 \cdot 0 + 0.000 \cdot 50 \\ &= 2.820.\end{aligned}$$

The final value for control variable is thus

$$\eta = 3/5 \cdot 1.873 + 2/5 \cdot 2.820 = 2.2518.$$

Outline

1. Mamdani-Assilian Controller

2. Examples

3. Takagi-Sugeno Controller

4. Control based on Fuzzy Equivalence Relations

Similarity

Fuzzy Equivalence Relations

Extensional Hull

Fuzzy Equivalence Relations: Fuzzy Control

Interpolation in the Presence of Fuzziness

Both Takagi-Sugeno and Mamdani are based on heuristics.

They are used without a concrete interpretation.

Fuzzy control is interpreted as a method to specify a non-linear transition function by knowledge-based interpolation.

A fuzzy controller can be interpreted as fuzzy interpolation.

Now recall the concept of **fuzzy equivalence relations** (also called **similarity relations**).

Similarity: An Example

Specification of a partial control mapping (“good control actions”):

		gradient						
		-40.0	-6.0	-3.0	0.0	3.0	6.0	40.0
deviation	-70.0	22.5	15.0	15.0	10.0	10.0	5.0	5.0
	-50.0	22.5	15.0	10.0	10.0	5.0	5.0	0.0
	-30.0	15.0	10.0	5.0	5.0	0.0	0.0	0.0
	0.0	5.0	5.0	0.0	0.0	0.0	-10.0	-15.0
	30.0	0.0	0.0	0.0	-5.0	-5.0	-10.0	-10.0
	50.0	0.0	-5.0	-5.0	-10.0	-15.0	-15.0	-22.5
	70.0	-5.0	-5.0	-15.0	-15.0	-15.0	-15.0	-15.0

Interpolation of Control Table

There might be additional knowledge available:

Some values are “indistinguishable”, “similar” or “approximately equal”.

Or they should be treated in a similar way.

Two problems:

- a) How to model information about similarity?
- b) How to interpolate in case of an existing similarity information?

How to Model Similarity?

Proposal 1: Equivalence Relation

Definition

Let A be a set and \approx be a binary relation on A . \approx is called an equivalence relation if and only if $\forall a, b, c \in A$,

- (i) $a \approx a$ (reflexivity)
- (ii) $a \approx b \leftrightarrow b \approx a$ (symmetry)
- (iii) $a \approx b \wedge b \approx c \rightarrow a \approx c$ (transitivity).

Let us try $a \approx b \Leftrightarrow |a - b| < \varepsilon$ where ε is fixed.

\approx is not transitive, \approx is no equivalence relation.

Recall the Poincaré paradox: $a \approx b$, $b \approx c$, $a \not\approx c$.

This is counterintuitive.

How to Model Similarity?

Proposal 2: Fuzzy Equivalence Relation

Definition

A function $E : X^2 \rightarrow [0, 1]$ is called a fuzzy equivalence relation with respect to the t -norm \top if it satisfies the following conditions

- $$\forall x, y, z \in X \quad \begin{array}{ll} (i) & E(x, x) = 1 \quad \text{(reflexivity)} \\ (ii) & E(x, y) = E(y, x) \quad \text{(symmetry)} \\ (iii) & \top(E(x, y), E(y, z)) \leq E(x, z) \quad \text{(\textit{t}-transitivity)}. \end{array}$$

$E(x, y)$ is the degree to which $x \approx y$ holds.

E is also called similarity relation, t -equivalence relation, indistinguishability operator, or tolerance relation.

Note that property *(iii)* corresponds to the vague statement if $(x \approx y) \wedge (y \approx z)$ then $x \approx z$.

Fuzzy Equivalence Relations: An Example

Let δ be a pseudo metric on X .

Furthermore $\top(a, b) = \max\{a + b - 1, 0\}$ Łukasiewicz t -norm.

Then $E_\delta(x, y) = 1 - \min\{\delta(x, y), 1\}$ is a fuzzy equivalence relation.

$\delta(x, y) = 1 - E_\delta(x, y)$ is the induced pseudo metric.

Here, fuzzy equivalence and distance are dual notions in this case.

Definition

A function $E : X^2 \rightarrow [0, 1]$ is called a fuzzy equivalence relation if

$\forall x, y, z \in X$

- (i) $E(x, x) = 1$ (reflexivity)
- (ii) $E(x, y) = E(y, x)$ (symmetry)
- (iii) $\max\{E(x, y) + E(y, z) - 1, 0\} \leq E(x, z)$ (Łukasiewicz transitivity).

Fuzzy Sets as Derived Concept

$$\delta(x, y) = |x - y| \quad \text{metric}$$

$$E_\delta(x, y) = 1 - \min\{|x - y|, 1\} \quad \text{fuzzy equivalence relation}$$

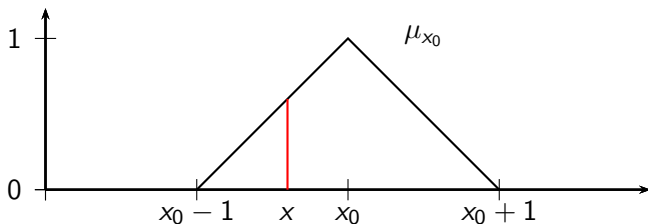

$$\mu_{x_0} : X \rightarrow [0, 1]$$

$$x \mapsto E_\delta(x, x_0) \quad \text{fuzzy singleton}$$

μ_{x_0} describes “local” similarities.

Extensional Hull

$E : \mathbb{R} \times \mathbb{R} \rightarrow [0, 1]$, $(x, y) \mapsto 1 - \min\{|x - y|, 1\}$ is fuzzy equivalence relation *w.r.t.* $\top_{\text{Łuka}}$.

Definition

Let E be a fuzzy equivalence relation on X *w.r.t.* \top .

$\mu \in \mathcal{F}(X)$ is extensional if and only if
 $\forall x, y \in X : \top(\mu(x), E(x, y)) \leq \mu(y)$.

Definition

Let E be a fuzzy equivalence relation on a set X .

Then the extensional hull of a set $M \subseteq X$ is the fuzzy set

$$\mu_M : X \rightarrow [0, 1], \quad x \mapsto \sup\{E(x, y) \mid y \in M\}.$$

The extensional hull of $\{x_0\}$ is called a singleton.

Specification of Fuzzy Equivalence Relation

Given a family of fuzzy sets that describes “local” similarities.

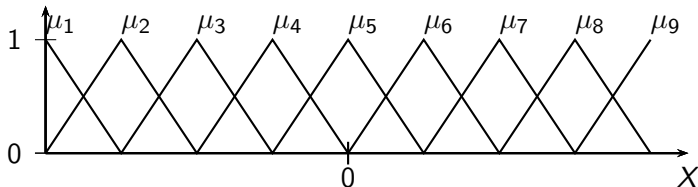

There exists a fuzzy equivalence relation on X with induced singletons μ_i if and only if

$$\forall i, j : \sup_{x \in X} \{ \mu_i(x) + \mu_j(x) - 1 \} \leq \inf_{y \in X} \{ 1 - |\mu_i(y) - \mu_j(y)| \}.$$

If $\mu_i(x) + \mu_j(x) \leq 1$ for $i \neq j$, then there is a fuzzy equivalence relation E on X

$$E(x, y) = \inf_{i \in I} \{ 1 - |\mu_i(x) - \mu_i(y)| \}.$$

Necessity of Scaling I

Are there other fuzzy equivalence relations on \mathbb{R} than
 $E(x, y) = 1 - \min\{|x - y|, 1\}$?

Integration of scaling.

A fuzzy equivalence relation depends on the measurement unit, e.g.

- Celsius: $E(20^\circ\text{C}, 20.5^\circ\text{C}) = 0.5$,
- Fahrenheit: $E(68^\circ\text{F}, 68.9^\circ\text{F}) = 0.9$,
- scaling factor for Celsius/Fahrenheit = 1.8 ($F = 9/5C + 32$).

$E(x, y) = 1 - \min\{|c \cdot x - c \cdot y|, 1\}$ is a fuzzy equivalence relation!

Necessity of Scaling II

How to generalize scaling concept?

$$X = [a, b].$$

Scaling $c : X \rightarrow [0, \infty)$.

Transformation

$$f : X \rightarrow [0, \infty), \quad x \mapsto \int_a^x c(t) dt.$$

Fuzzy equivalence relation

$$E : X \times X \rightarrow [0, 1], \quad (x, y) \mapsto 1 - \min\{|f(x) - f(y)|, 1\}.$$

Fuzzy Equivalence Relations: Fuzzy Control

The imprecision of measurements is modeled by a fuzzy equivalence relations E_1, \dots, E_n and F on X_1, \dots, X_n and Y , resp.

The information provided by control expert are

- k input-output tuples $(x_1^{(r)}, \dots, x_n^{(r)}, y^{(r)})$ and
- the description of the fuzzy equivalence relations for input and output spaces, resp.

The goal is to derive a control function $\varphi : X_1 \times \dots \times X_n \rightarrow Y$ from this information.

Determine Fuzzy-valued Control Functions I

The extensional hull of graph of φ must be determined.

Then the equivalence relation on $X_1 \times \dots \times X_n \times Y$ is

$$E((x_1, \dots, x_n, y), (x'_1, \dots, x'_n, y')) \\ = \min\{E_1(x_1, x'_1), \dots, E_n(x_n, x'_n), F(y, y')\}.$$

Determine Fuzzy-valued Control Functions II

For X_i and Y , define the sets

$$X_i^{(0)} = \{x \in X_i \mid \exists r \in \{1, \dots, k\} : x = x_i^{(r)}\}$$

and

$$Y^{(0)} = \{y \in Y \mid \exists r \in \{1, \dots, k\} : y = y^{(r)}\}.$$

$X_i^{(0)}$ and $Y^{(0)}$ contain all values of the r input-output tuples $(x_1^{(r)}, \dots, x_n^{(r)}, y^{(r)})$.

For each $x_0 \in X_i^{(0)}$, singleton μ_{x_0} is obtained by

$$\mu_{x_0}(x) = E_i(x, x_0).$$

Determine Fuzzy-valued Control Functions III

If φ is only partly given, then use E_1, \dots, E_n, F to fill the gaps of φ_0 .

The extensional hull of φ_0 is a fuzzy set

$$\begin{aligned} \mu_{\varphi_0}(x'_1, \dots, x'_n, y') \\ = \max_{r \in \{1, \dots, k\}} \left\{ \min \{ E_1(x_1^{(r)}, x'_1), \dots, E_n(x_n^{(r)}, x'_n), F(y^{(r)}, y') \} \right\}. \end{aligned}$$

μ_{φ_0} is the smallest fuzzy set containing the graph of φ_0 .

Obviously, $\mu_{\varphi_0} \leq \mu_{\varphi}$

$$\begin{aligned} \mu_{\varphi_0}^{(x_1, \dots, x_n)} : Y &\rightarrow [0, 1], \\ y &\mapsto \mu_{\varphi_0}(x_1, \dots, x_n, y). \end{aligned}$$

Reinterpretation of Mamdani Controller

For input (x_1, \dots, x_n) , the projection of the extensional hull of graph of φ_0 leads to a fuzzy set as output.

This is identical to the Mamdani controller output.

It identifies the input-output tuples of φ_0 by linguistic rules:

R_r : **if** \mathcal{X}_1 **is** *approximately* $x_1^{(r)}$
and ...
and \mathcal{X}_n **is** *approximately* $x_n^{(r)}$
then \mathcal{Y} **is** $y^{(r)}$.

A fuzzy controller based on equivalence relations behaves like a Mamdani controller.

Reinterpretation of Mamdani Controller

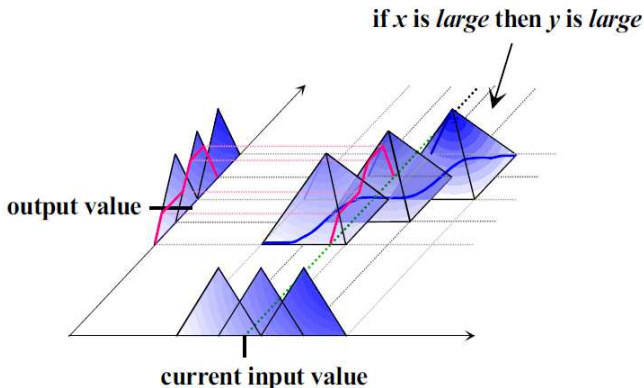

3 fuzzy rules (specified by 3 input-output tuples).

The extensional hull is the maximum of all fuzzy rules.

Literature about Fuzzy Control

-  Michels, K., Klawonn, F., Kruse, R., and Nürnberger, A. (2003).
Fuzzy Regelung: Grundlagen, Entwurf, Analyse.
Springer-Lehrbuch. Springer, Berlin / Heidelberg, Germany.
-  Michels, K., Klawonn, F., Kruse, R., and Nürnberger, A. (2006).
Fuzzy Control: Fundamentals, Stability and Design of Fuzzy Controllers, volume 200 of *Studies in Fuzziness and Soft Computing.*
Springer, Berlin / Heidelberg, Germany.

